

PVE52



Rated Load
238 kg



Panoramic view
360°



Unique Design



Vacuum
Technology



Installation
within 2-3 days



Plug&Play
Single phase 220v



Customizable
finishes



Minimal
maintenance



Eco-friendly



No pit
required



Maximum
Safety



General

External cylinder diameter (mm)	1316
Rated load (kg)	238
Speed	<0.15m/s
Number of stops	2 to 5
Maximum Total travel (m)	15

Doors

Available Door openings	0° and 180°
Default hinges position (from outside the cabin)	Right
Optional hinges position (from outside the cabin)	Left
Automatic door option	Yes
Door height (mm)	2024
Height upto top of the door closer (mm)	2078

Cabin

Internal cabin height (mm)	2010
Interior cabin diameter (mm)	
without columns	1210
between columns	1096
Entrance width opening (mm)	813
Electrical circuits with all controls in cabin	24V
Automatic Push (one-touch press)	Yes
Foldable cabin seat	No
Wheelchair accessible	Yes

Security









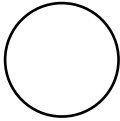

Automatic descent in the event of power failure	Yes
Mechanical emergency brakes	Yes
Overload limiting system	Yes
Alarm button	Yes
Telephone	Yes
Electromechanical interlocks at each landing	Yes

Installation requirements

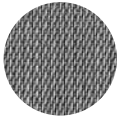
Through floor perforation required diameter (mm)	1389
Minimum height in upper floor (mm)	2450
Level ground	Yes

Electricity/Power

Power Supply	220V single-phase line of 3 (phase, neutral, earth) x 10mm (cross-section of each cable)
Maximum power	6kW
Required protection	32A Circuit Breaker

	Structure Colours	Cabin Floor	Ceiling Finishes
Standard Colours	 White	 Golden Brown	 Brushed
	 Bluish Grey	 Metallic	 Mirror
	 Light Grey	 Black	
	Special Colours	 Matte Black	
 Silver			
 Taupe			

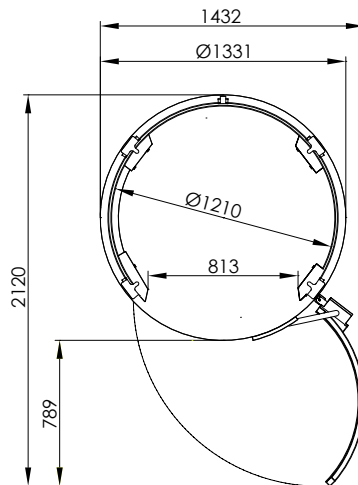

DOOR OPENINGS

